

SPECIFICATION FOR APPROVAL

REF :

PAGE: 1

PROD. NAME	WOUND CHIP INDUCTOR	ABC'S DWG NO.	CC4532□□□□L□
		ABC'S ITEM NO.	

I . CONFIGURATION & DIMENSIONS :

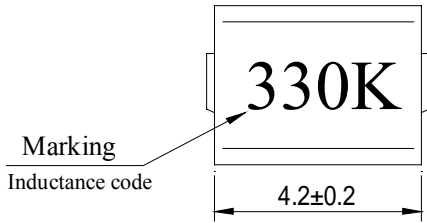

A :	4.5±0.3		m/m
B :	3.2±0.2		m/m
C :	3.2±0.2		m/m
E :	1.2		m/m
F :	1.0		m/m

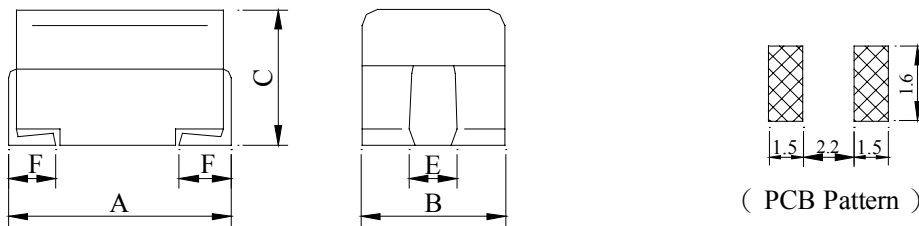

II . SCHEMATIC DIAGRAM :

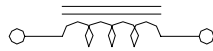

III . MATERIALS :

- a . Core : Ferrite DR core
- b . Wire : Enamelled copper wire (class H)
- c . Terminal : Cu/Sn (lead content 100 ppm max.)
- d . Encapsulate : Epoxy novolac molding compound
- e . Remark : Ferrite body is exempted with lead content under RoHS regulation

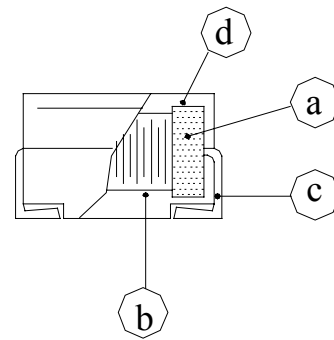

IV . GENERAL SPECIFICATION :

- a . Temp. rise : 20°C max.
- b . Ambient temp. : 100°C max.
- c . Storage temp. : -40°C ----+125°C
- d . Operating temp. : -40°C ----+125°C
- e . Terminal strength : 1.0 kg min.
- f . Rated current : Current cause
inductance drop within 10%
- g . Resistance to solder heat : 260°C.10 secs.
- h . Resistance to solvent : Per MIL-STD-202F

Peak Temp : 245°C max.
Max time above 225°C : 30sec max.
Max time above 200°C : 50sec max.

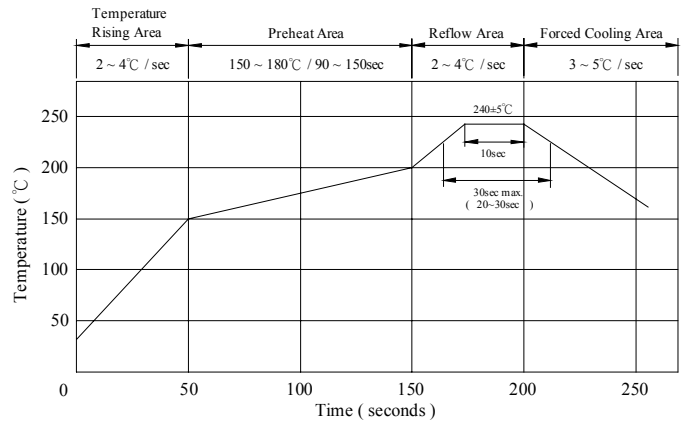

AE-001A

SPECIFICATION FOR APPROVAL

REF :

PAGE: 2

PROD. NAME	WOUND CHIP INDUCTOR	ABC'S DWG NO.	CC4532□ □ □ □ L□
		ABC'S ITEM NO.	

V . ELECTRICAL CHARACTERISTICS :

DWG NO.	Inductance (μ H)	Q min.	Test Freq. (MHz)	SRF (MHz) min.	RDC (Ω) max.	IDC (mA) max.
CC45321R0KL□	1.00 \pm 10%	10	7.96	180.0	0.11	1050
CC45321R2KL□	1.20 \pm 10%	10	7.96	160.0	0.12	1000
CC45321R5KL□	1.50 \pm 10%	10	7.96	130.0	0.15	950
CC45321R8KL□	1.80 \pm 10%	10	7.96	100.0	0.16	900
CC45322R2KL□	2.20 \pm 10%	10	7.96	80.0	0.18	850
CC45322R7KL□	2.70 \pm 10%	10	7.96	60.0	0.20	800
CC45323R3KL□	3.30 \pm 10%	10	7.96	45.0	0.22	750
CC45323R9KL□	3.90 \pm 10%	10	7.96	40.0	0.24	700
CC45324R7KL□	4.70 \pm 10%	10	7.96	35.0	0.27	650
CC45325R6KL□	5.60 \pm 10%	10	7.96	30.0	0.30	650
CC45326R8KL□	6.80 \pm 10%	10	7.96	28.0	0.35	600
CC45328R2KL□	8.20 \pm 10%	10	7.96	25.0	0.40	600
CC4532100KL□	10.00 \pm 10%	10	2.52	22.0	0.50	550
CC4532120KL□	12.00 \pm 10%	10	2.52	21.0	0.60	500
CC4532150KL□	15.00 \pm 10%	10	2.52	20.0	0.70	450
CC4532180KL□	18.00 \pm 10%	10	2.52	19.0	0.80	400
CC4532220KL□	22.00 \pm 10%	10	2.52	18.0	0.90	370
CC4532270KL□	27.00 \pm 10%	10	2.52	16.0	1.20	330
CC4532330KL□	33.00 \pm 10%	10	2.52	14.0	1.40	300
CC4532390KL□	39.00 \pm 10%	10	2.52	12.0	1.60	280
CC4532470KL□	47.00 \pm 10%	10	2.52	11.5	1.90	260
CC4532560KL□	56.00 \pm 10%	10	2.52	11.0	2.20	240
CC4532680KL□	68.00 \pm 10%	10	2.52	10.0	2.60	220
CC4532820KL□	82.00 \pm 10%	10	2.52	9.0	3.50	200
CC4532101KL□	100.00 \pm 10%	20	0.796	8.0	4.00	180
CC4532121KL□	120.00 \pm 10%	20	0.796	7.5	4.50	160
CC4532151KL□	150.00 \pm 10%	20	0.796	7.0	6.50	140
CC4532181KL□	180.00 \pm 10%	20	0.796	6.5	7.50	120
CC4532221KL□	220.00 \pm 10%	20	0.796	5.5	9.00	120
CC4532271KL□	270.00 \pm 10%	20	0.796	5.0	11.00	100
CC4532331KL□	330.00 \pm 10%	20	0.796	4.0	13.00	90

1). □ : Packaging information... [A]: Bulk [B]: Taping Reel

SPECIFICATION FOR APPROVAL

REF :

PAGE: 3

PROD. NAME	WOUND CHIP INDUCTOR	ABC'S DWG NO. ABC'S ITEM NO.	CC4532□ □ □ □ L□
---------------	---------------------	---------------------------------	------------------

VI . CURVE :

@ Inductance VS. DC Superposition Characteristics

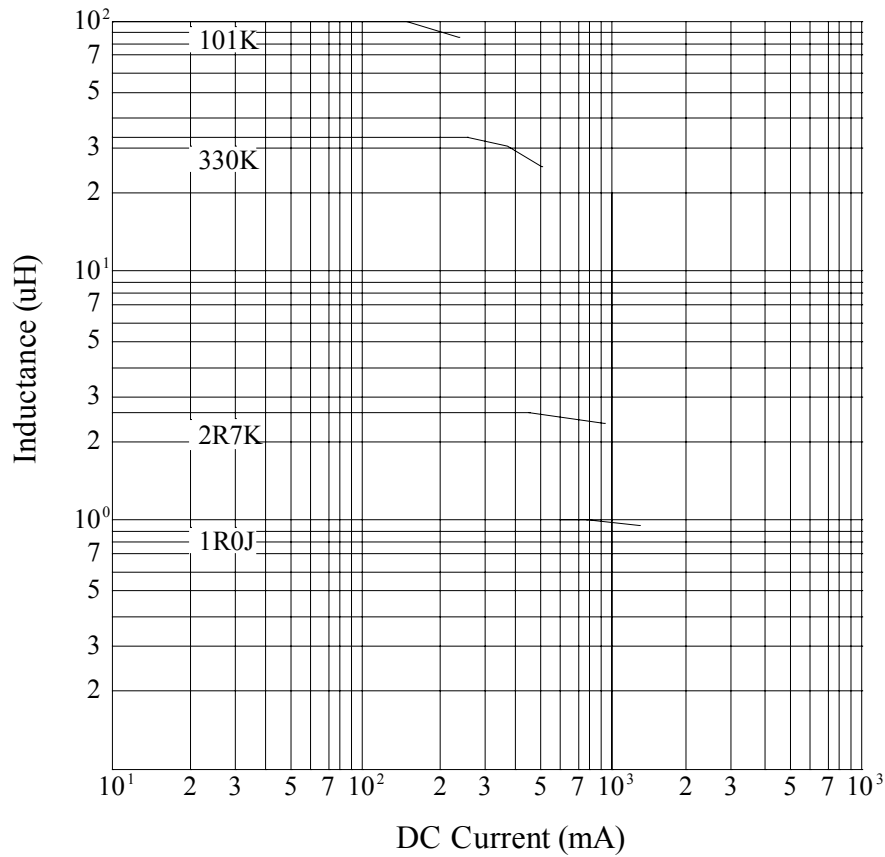

@ Q VS. Frequency Response

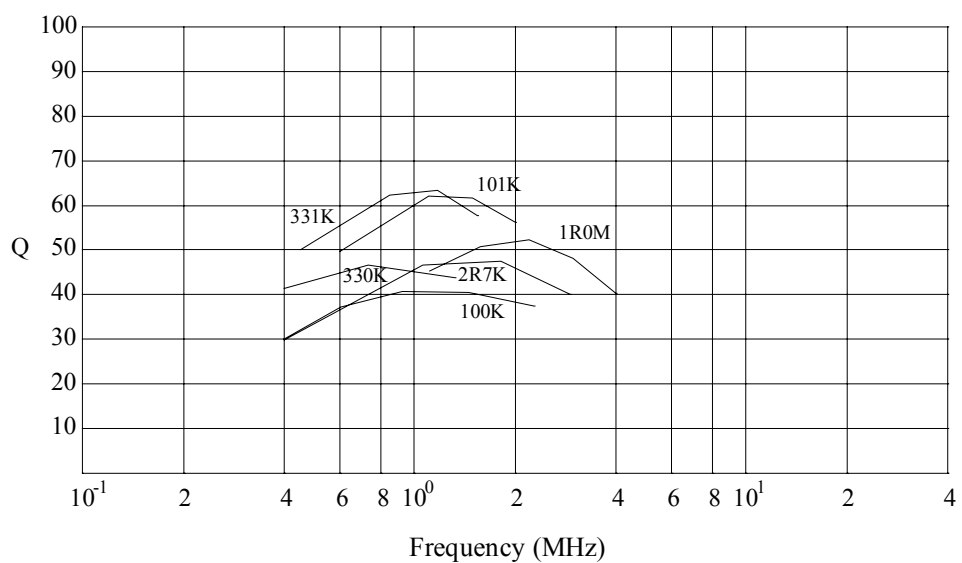

AE-001A

SPECIFICATION FOR APPROVAL

REF :

PAGE: 4

PROD. NAME	WOUND CHIP INDUCTOR	ABC'S DWG NO.	CC4532□□□□L□
		ABC'S ITEM NO.	

VII . PACKAGING INFORMATION :

(1) Configuration

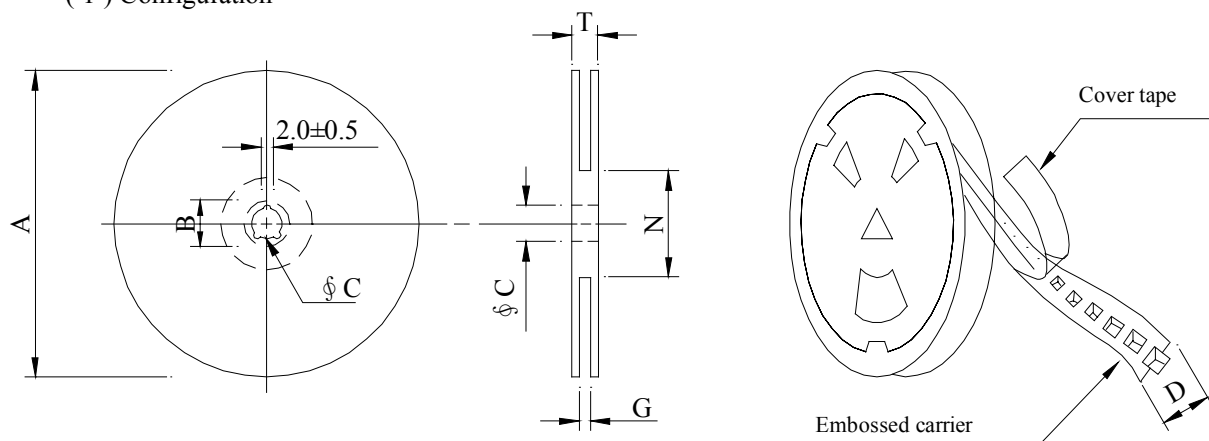

※Carrier tape width : D

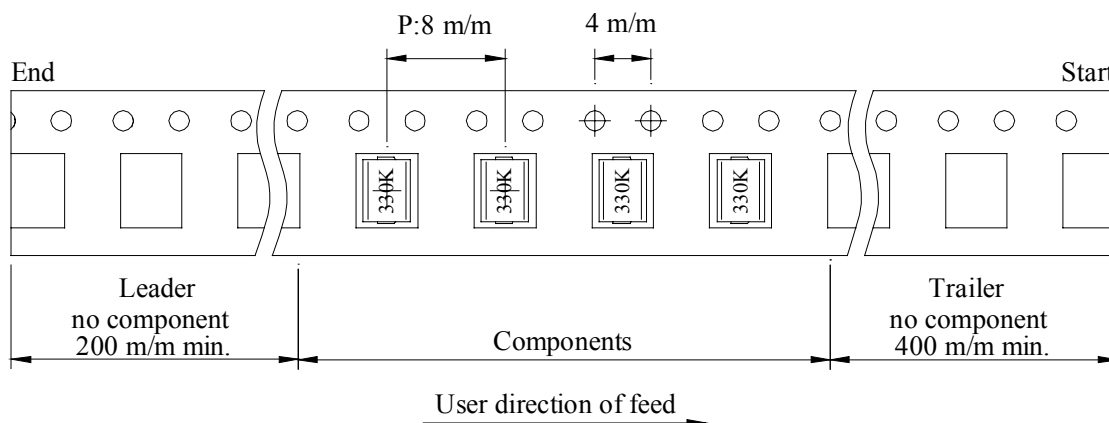

(2) Dimensions

Unit:m/m

Style	A	B	C	D	G	N	T
07 - 12	178	21±0.8	13	12	14 ⁺⁰	50 ⁻⁰	16.5

(3) Q'TY & G.W. Per package

Series	Inner : Reel			Outer : Carton		
	Q'TY (pcs)	G.W. (gw)	Style	Q'TY (pcs)	G.W. (Kg)	Size (cm)
CC4532	500	140	07 - 12	20,000	8.00	41 x 39 x 22

AE-001A

SPECIFICATION FOR APPROVAL

REF :

PAGE: 5

PROD. NAME	WOUND CHIP INDUCTOR	ABC'S DWG NO.	CC4532□ □ □ □ L□
		ABC'S ITEM NO.	

VIII . DWG EXPRESSION :

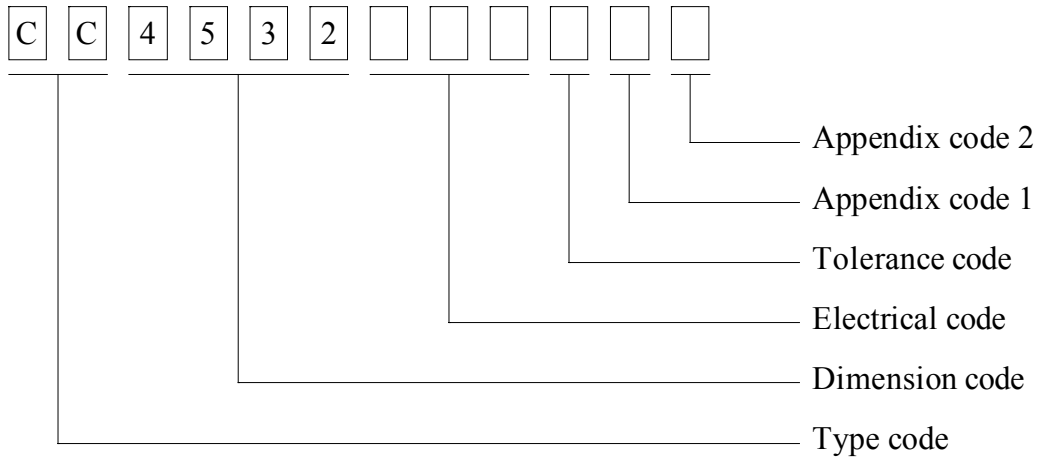

Appendix code 1 : S : Standard products

A~K , M~R , T~Z : Special products

L : Standard Lead Free products

1 ~ 9 : Special Lead Free products

Appendix code 2 :

Code	Inner package	Inner package Q'TY	Remark
A	Bag	500 pcs	
B	T / R (Reel package)	500 pcs	

SPECIFICATION FOR APPROVAL

REF :

PAGE: 6

PROD. NAME	WOUND CHIP INDUCTOR	ABC'S DWG NO.	CC4532□ □ □ □ L□
		ABC'S ITEM NO.	

IX . RELIABILITY TEST :

Test item	Specification	Test condition / Test method
● Electrical performance test		
Inductance L	Refer to standard electrical characteristic list	□ HP4194A with HP-16034E test fixture
Q		
Self resonance frequency SRF		□ HP4291A with HP-16093A test fixture
DC Resistance RDC		CH-502AC
Rated current IDC		Applied the current to coils , The Inductance change shall be less than 10% to initial value & temperature rise shall not be more than 20°C
Temperature rise test	20°C max.	1 . Applied the allowed DC current for 10 minutes 2 . Temperature measure by digital surface thermometer
Over load test	After test , Inductors shall be no evidence of electrical and mechanical damage	Applied 2 times of rated allowed DC current to inductor for a period of 5 minutes
Withstanding voltage test	After tset , Inductors shall be no evidence of electrical and mechanical damage	AC voltage of 1000VAC applied between inductors terminal and coating for 5 seconds
Insulation resistance test	1000 MΩ min .	100 VDC applied between inductor terminal and coating
● Mechanical performance test		
Vibration test (Low frequency)	1 . Inductors shall be no evidence of electrical and mechanical damage 2 . Inductance shall not change more than± 5% 3 . Q Shall not change more than ± 20%	1 . Amplitude : 1.5 m/m 2 . Frequency : 10 -- 55 -- 10 Hz / 1min. 3 . Direction : X , Y , Z 4 . Duration : 2 hrs / X , Y , Z
Shock test		Inductors shall be dropped 10 times from a height of 1m onto 3cm wooden board
Resistance to soldering heat		Temp : 260± 5°C Time : 10± 1.0 sec.

AE-001A



SPECIFICATION FOR APPROVAL

REF :

PAGE: 8

PROD. NAME	WOUND CHIP INDUCTOR	ABC'S DWG NO.	CC4532□ □ □ □ L□
		ABC'S ITEM NO.	

X . UL CARD :

OBMW2 August 27, 1999

Magnet Wire-Component

ELEKTRISOLA (MALAYSIA) SDN BHD E143312
 IALAN DAMN SATU IANDA BAIK 28750 BENTONG, PAHANG
 DARUL MAKMUR MALAYSIA

Mtl Dsg	Mark Dsg	Coating Type		ANSI Typ	Temp Class
		BC	OC		
Estersol 160	E180	Polyesterimide (solderable)	—	MW-77	180
Amldester 200	A200	Polyesterimide	—	MW-74	200
Polysol-N 155	PN155	Polyurechane	Nylon	MW-80, MW-28	155, 100
Polysol 155	P155	Polyurechane	—	MW-79, MW-79	155, 130
Polysol 155g	Pg155	Polyurechane	—	MW-79	130
Polysol 155p	Pp155, Gp155	Polyurechane	—	MW-79	155
Polysol 160	P160	Polyurechane	—	MW-79	155
Polysol 180	P180	Polyurechane	—	MW-79	155
Polysol 170	P170 or G170	Polyurechane	—	MW-79	156
Polysol-N 180	PN180	Polyurechane	Nylon	—	180

Marking : Company name/material designation or marked designation and factory identification on package ok reel

See General Information preceding These Recognitions
 For use only in equipment where the acceptability of the combination is determined by Underwriters Laboratories Inc.

OMFZ2 March 4, 1994

Component-Plastics

CHANG CHUN PLASTICS CO LTD E59481 (S)
 (F1-cont. from F card)

BM-21	ALL	0.79	94HB	50	50	50	—	—	—	—	—
BM-22	ALL	0.79	94HB	50	50	50	—	—	—	—	—
BM-23	ALL	0.79	94V-0	50	50	50	—	—	—	—	—
EME-1100	BK	0.84	94V-0	130	130	130	—	—	—	—	—
	BK	6.4	94V-0	130	130	130	—	—	—	—	—
EME-1200	BK	0.84	94V-0	130	130	130	—	—	—	—	—
	BK	6.4	94V-0	130	130	130	—	—	—	—	—
EME-5961C	BK	0.3	94V-0	130	130	130	—	—	—	—	—
	BK	3.1	94V-0	130	130	130	—	—	—	—	—

Reports: January 19, 1988: January 19, 1988: January 19, 1988: June 2, 1988;
 June 2, 1998: June 2, 1988.

Replaces E59481C dated February 7, 1989. (Cont. on C1 card)
 262854001 N7047 Underwriters Laboratories Inc.® D11/0018965

AE-001A

